





BCY414 型光 MOS 继电器

产品图片	Features 产品特性	Application 应用
 DIP4	<ul style="list-style-type: none"> ● Contact Form 触点形式 1b ● Load Voltage 输出电压 400V ● Load Current 输出电流 120mA ● Low Off-State Leakage Current 漏电流 10μA 	<ul style="list-style-type: none"> ● Automatic Test Equipment 自动检测设备 ● Security Equipment 安全设备 ● Sensing Equipment 传感设备 ● Telephone Equipment 通信设备 ● I/O Modules I/O 模块 ● Modem 调制解调器
 SMD4		

Type 种类

Output rating 输出额定		Marking model 标刻型号	Part No. 订货型号	
Load voltage 负载电压	Load current 负载电流		DIP 双列直插	SMD 表面贴装
400V	0.12A	BCY414	BCY414	BCY414A

注：表示引脚类型的“A”未标刻在产品上，订货依据订货示例型号。

Dimensions 外形尺寸

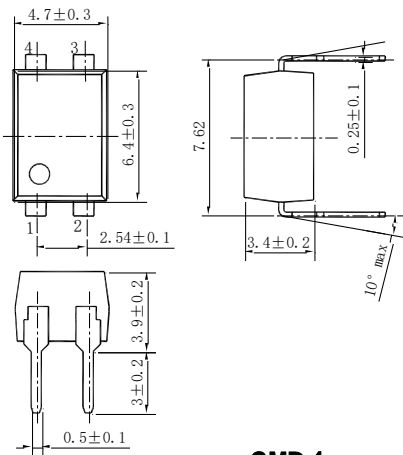

SMD4

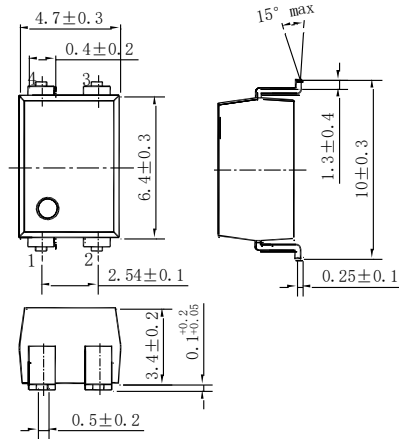

DIP4

Terminal Identification 引脚标识

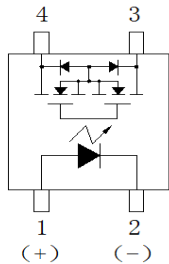

Wiring Diagram 接线图

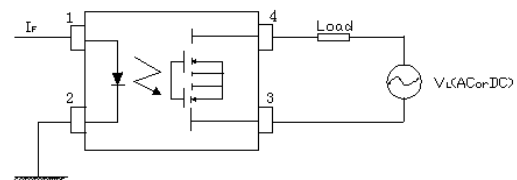

通讯地址：陕西省西安市国家民用航天产业基地航天中路385号众创广场11层1101.1102.1104室

生产地址：陕西省宝鸡市陈仓区群力路1号 邮政编码：721300

电话：(0917)-6293969 18609177833 传 真：(0917)-6293969



BCY414 型光 MOS 继电器

Technical parameters 技术参数 (Ambient Temperature 25°C)

I/O Absolute Maximum Ratings 输入输出电气参数最大值

	Item 项目	Symbol 符号	Value 数值
Operating Temperature 工作温度		T_{OPR}	-40°C~+85°C
Storage Temperature 储存温度		T_{STG}	-40°C~+100°C
Input 输入	Continuous LED Current 工作电流	I_F	50mA
	Peak LED Current LED 峰值电流 (f=100Hz, Duty=1%)	I_{FP}	500mA
	LED Reverse Voltage 反向电压	V_R	5V
	Input Power Dissipation 输入功耗	P_{IN}	75mW
Output 输出	Load Voltage 输出电压	V_L	400V (AC peak or DC)
	Load Current 输出电流	I_L	120mA
	Peak Load Current 峰值输出电流 ((1ms, 1 shot)	I_{PEAK}	0.3A
	Output Power Dissipation 输出功耗	P_{OUT}	500mW
Total Power Dissipation 总功耗		P_T	550mW
I/O Breakdown Voltage 输入输出间隔离电压		$V_{I/O}$	3750Vrms

Electrical Specifications 输入输出电气参数

	Item 项目	Symbol 符号	MIN. 最小值	TYP. 典型值	MAX. 最大值	Units 单位	Conditions 条件
Input 输入	LED Forward Voltage 正向电压	V_F		1.2	1.4	V	$I_F=10mA$
	Operation LED Current 接通电流	$I_{F ON}$		0.5	3.0	mA	
	Recovery LED Voltage 关断电压	$V_{F OFF}$	0.5			V	
Output 输出	On-Resistance 导通电阻	R_{ON}		20	50	Ω	$I_F=0mA, I_L=50mA,$ (within 10msec.)
	Off-State Leakage Current 漏电流	I_{LEAK}			10	μA	$I_F=5mA, V_L=400V$
	Output Capacitance 输出端容量	C_{OUT}		165		pF	$I_F=5mA, V_L=0, f=1MHz$
Timeparameters 时间参数	Turn-On Time 接通时间	T_{ON}		0.02	1.0	ms	$I_F=5mA, I_L=50mA$
	Turn-Off Time 关断时间	T_{OFF}		0.5	3.0	ms	
I/O 输入输出	I/O Insulation Resistance 绝缘电阻	$R_{I/O}$	10^{10}			Ω	DC=500V
	I/O Capacitance 隔离电容	$C_{I/O}$		0.8		pF	f=1MHz

通讯地址: 陕西省西安市国家民用航天产业基地航天中路385号众创广场11层1101.1102.1104室

生产地址: 陕西省宝鸡市陈仓区群力路1号 邮政编码: 721300

电话: (0917)-6293969 18609177833 传 真: (0917)-6293969



BCY414 型光 MOS 继电器

Reference Data 参考数值 (BCY414)

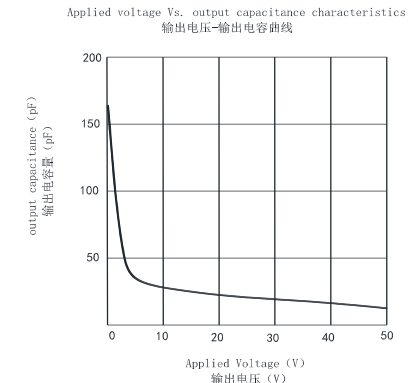
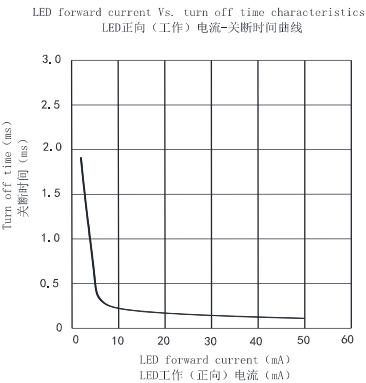
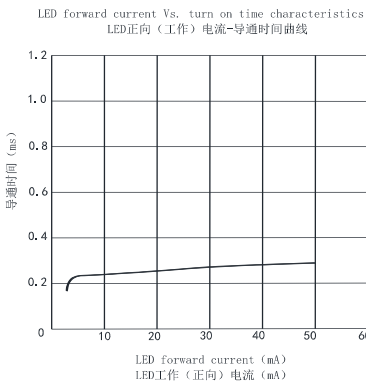
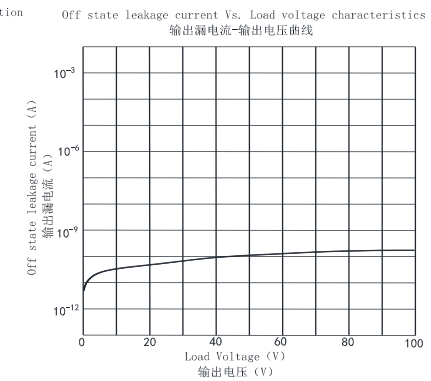
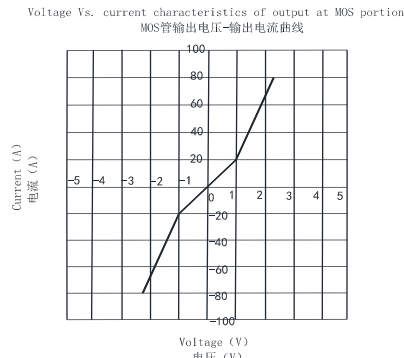
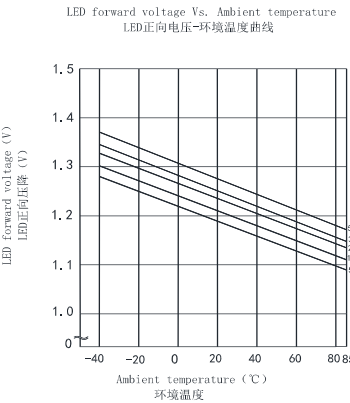
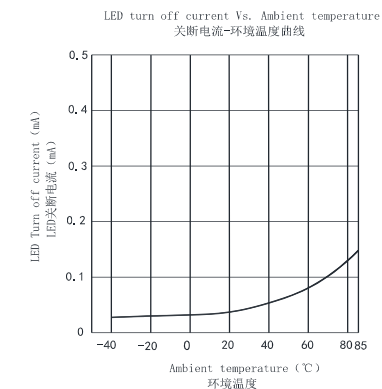
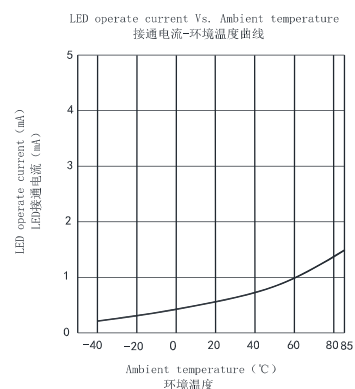
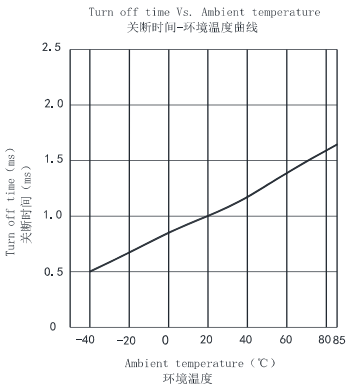
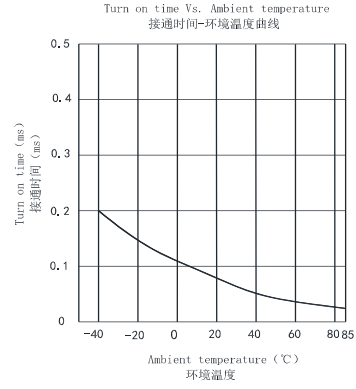
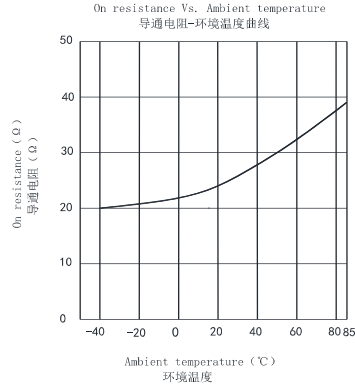
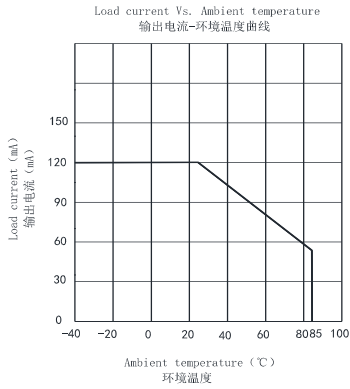

通讯地址: 陕西省西安市国家民用航天产业基地航天中路385号众创广场11层1101.1102.1104室

生产地址: 陕西省宝鸡市陈仓区群力路1号 邮政编码: 721300

电话: (0917)-6293969 18609177833 传真: (0917)-6293969